

FITTING INSTRUCTION

Clamp mark in acc. with		Cables joining
ISO	PN	
1	L	Left directional lights
2	+	Rear fog lights
3	31	Ground
4	R	Right directional lights
5	58R	Right side parking lights
6	54	Stoplights
7	58L	Left side parking lights

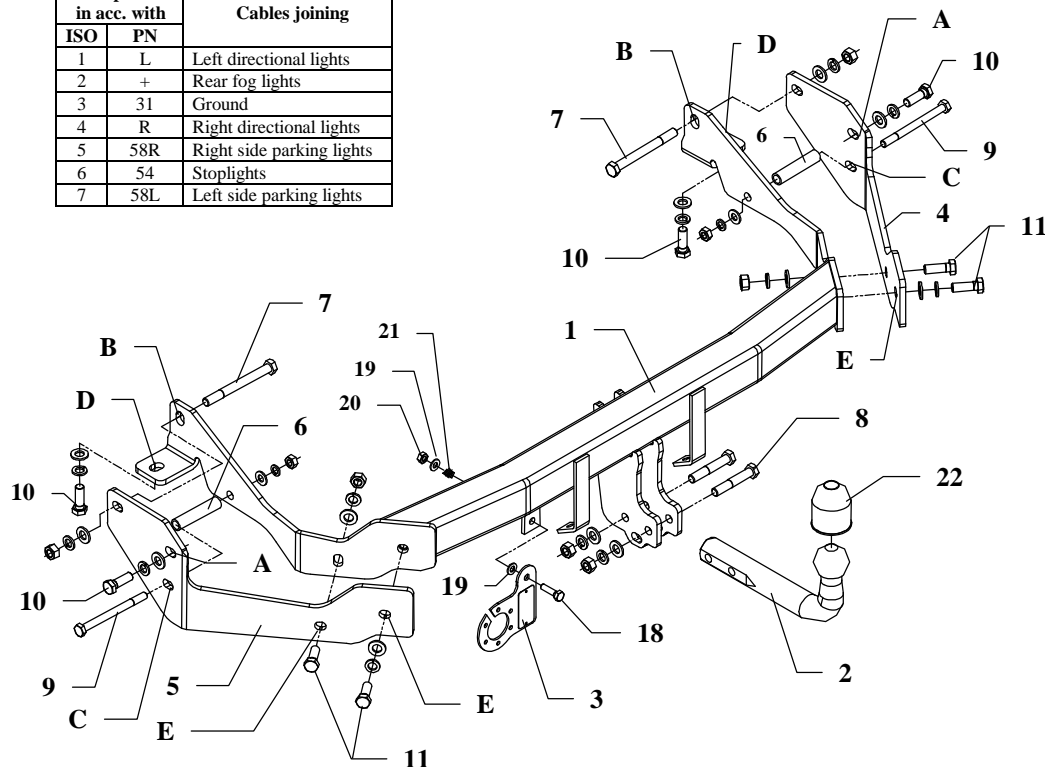

This towing hitch is designed to assembly in following cars:
HYUNDAI SANTA FE, produced since 2000 till 2005, catalogue number **J42** and is prepared to tow trailers max total weight **2300 kg** and max vertical load **92 kg**.

From manufacturer

Thank you for buying our product. Their reliability has been confirmed in many tests. Reliability of towing hitch depends also on correct assembly and right operation. For this reasons we kindly ask to read carefully this instruction and apply to hints.

The towing hitch should be install in points described by a car producer.

The instruction of the assembly

1. Disassemble the bumper.
2. Disassemble original towing handles – not used any more.
3. Get lower the muffler (take him out from last handles).
4. Get lower the spare wheel.
5. At holes A in side brackets 4 and 5 fix it loosely to the chassis frame using bolts M12x1,25x35mm (pos. 10).
6. Fix loosely main bar of the towing hitch (pos. 1) to the frame in order:
 - through holes B using bolts M12x120mm (pos. 7)
 - through holes C using bolts M10x120mm (pos. 9), use distance sleeves (pos. 6)
 - through holes D using bolts M12x1,25x35mm (pos. 10)
 - through holes E using bolts M12x35mm (pos. 11)
7. On plastic part of the bumper (in bottom part) cut out fragment according to ball brackets distance.
8. Reassemble the bumper.
9. Fix tight all bolts according to the torque shown in the table.
10. Fix tow-ball (pos. 2) using bolts M12x70mm (pos. 8) from accessories.
11. Fix the socket plate (pos. 3) as shown on the drawing.
12. Connect electric wires of 7-poles socket according to the instruction of the car. (Recommend to make at authorized service station)
13. Complete paint layer damaged during installation.

Torque settings for nuts and bolts (8,8):	
M 8 - 25 Nm	M 10 - 55 Nm
M 12 - 85 Nm	M 14 - 135 Nm











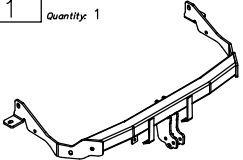
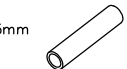



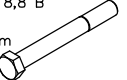

NOTE

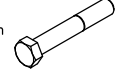
After install the towing hitch you should get adequate note in registration book (at authorised service station).The car should be equipped with:

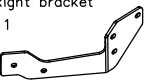
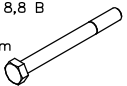
- Indicators
- Tow mirrors

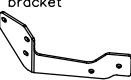
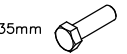
After 1000km check all bolts and nuts. The ball of towing hitch must be always kept clear and conserve with a grease.

Towing hitch accessories:

Pos. 1 Name: Main bar Quantity: 1 	Pos. 6 Name: Distance sleeve Quantity: 2 Dim.: $\phi 17,2 \times 2,35$ mm L=78mm 	Pos. 12 Name: Nut 8 B Quantity: 6 Dim.: M12 	Pos. 18 Name: Bolt 8,8 B Quantity: 1 Dim.: M8x30mm 
Pos. 2 Name: Tow ball Quantity: 1 	Pos. 7 Name: Bolt 8,8 B Quantity: 2 Dim.: M12x120mm 	Pos. 13 Name: Nut 8 B Quantity: 2 Dim.: M10 	Pos. 19 Name: Plain washer Quantity: 2 Dim.: $\phi 8,5$ mm 
Pos. 3 Name: Socket plate Quantity: 1 	Pos. 8 Name: Bolt 8,8 B Quantity: 2 Dim.: M12x70mm 	Pos. 14 Name: Plain washer Quantity: 12 Dim.: $\phi 13$ mm 	Pos. 20 Name: Nut 8 B Quantity: 1 Dim.: M8 
Pos. 4 Name: Right bracket Quantity: 1 	Pos. 9 Name: Bolt 8,8 B Quantity: 2 Dim.: M10x120mm 	Pos. 15 Name: Plain washer Quantity: 2 Dim.: $\phi 10,5$ mm 	Pos. 21 Name: Spring Quantity: 1 
Pos. 5 Name: Left bracket Quantity: 1 	Pos. 10 Name: Bolt 8,8 B Quantity: 4 Dim.: M12x1,25x35mm 	Pos. 16 Name: Spring washer Quantity: 12 Dim.: $\phi 12,2$ mm 	Pos. 22 Name: Ball cover Quantity: 1 
	Pos. 11 Name: Bolt 8,8 B Quantity: 4 Dim.: M12x35mm 	Pos. 17 Name: Spring washer Quantity: 2 Dim.: $\phi 10,2$ mm 	



PPUH AUTO-HAK S.J.

Produkcja Haków Holowniczych
Henryk & Zbigniew Nejman
76-200 SŁUPSK ul. Słoneczna 16K
tel/fax (059) 8-414-414; 8-414-413
E-mail: office@autohak.com.pl
www.autohak.com.pl

Towing hitch (without electrical set)

Class: **A50-X** Cat. no. **J42**

Designed for:

Manufacturer: **HYUNDAI**

Model: **SANTA FE**

produced since 2000 till 2005

Technical data:

D-value: 11,82 kN

maximum trailer weight: **2300 kg**

maximum vertical cup load: **92 kg**

Approval number according to Directive 94/20/EC: **e20*94/20*0297*00**

Foreword

This towing hitch is designed according to rules of safety traffic regulations. The towing hitch is a safety component and can be install only by qualified personnel. Any alteration or conversion of the towing hitch is prohibited and would lead to cancellation of design certification. Remove insulating compound and underseal from vehicle (if present) in the area of the matting surfaces of the towing hitch. The vehicle manufacturer's specifications regarding trailer load and max. vertical cup load are decisive for driving, and values for the towing hitch cannot be exceeded.

D-value formula:

$$\frac{\text{Max trailer weight [kg]} \times \text{Max vehicle weight [kg]}}{\text{Max trailer weight [kg]} + \text{Max vehicle weight [kg]}} \times \frac{9,81}{1000} = D \text{ [kN]}$$